

**CLEAR+**  
PROFESSIONAL HYGIENE PRODUCTS

## PAPELEIRA DE LIXO CLEAR+ 43 L BRANCA

### MANUAL DO UTILIZADOR – INSTRUÇÕES DE MONTAGEM



TRADUÇÕES

RO | SLO | HR | SK | HU | CZ | PL | FR | NL | SE | NO | FI | IT | ES | PT



4049657038963

ART. CÓDIGO: 1701671  
GTIN: 4049657038963

CWS HYGIENE INTERNATIONAL GMBH  
DREIEICH PLAZA 1A  
63303 DREIEICH, ALEMANHA  
WWW.CWS.COM / CONTACT@CWS.COM

#### INCLUÍDO NA ENTREGA

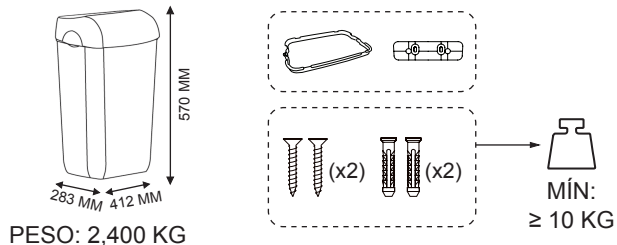

#### FERRAMENTAS NECESSÁRIAS

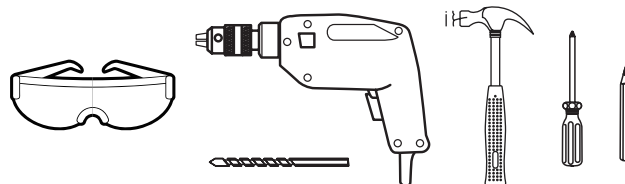

1

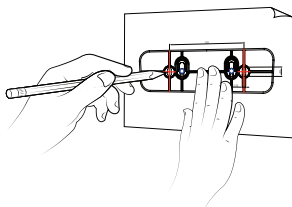

MARQUE A POSIÇÃO PARA EFETUAR OS ORIFÍCIOS DE MONTAGEM NA PAREDE.

ALTURA DE MONTAGEM RECOMENDADA DE 450 A 550 MM

2

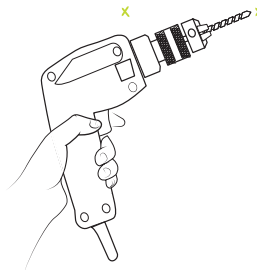

PERFURE OS ORIFÍCIOS MARCADOS.

3

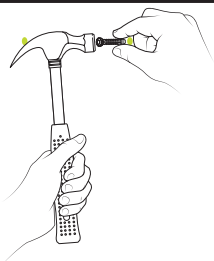

COLOQUE OS CASQUILHOS EM CADA ORIFÍCIO PERFURADO.

4

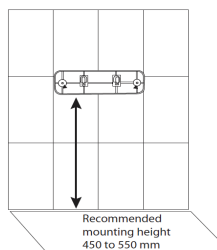

FIXE A PLACA À PAREDE UTILIZANDO O KIT DE PARAFUSOS.

5

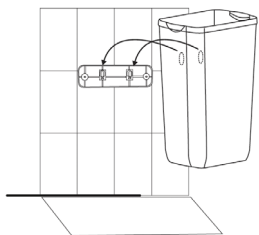

PENDURE A PAPELEIRA.

6

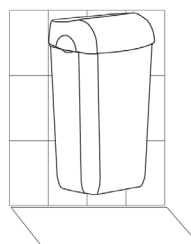

COLOQUE A TAMPA NA PAPELEIRA.

#### INCLUÍDO NA ENTREGA

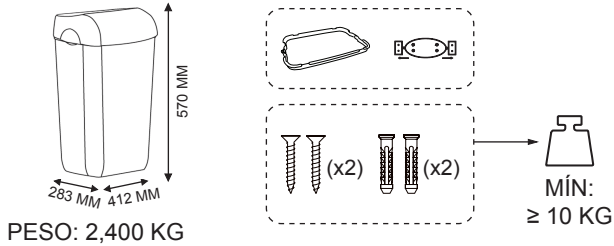

1

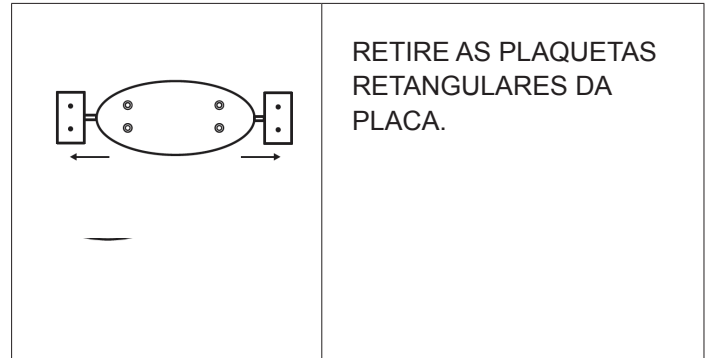

2



3

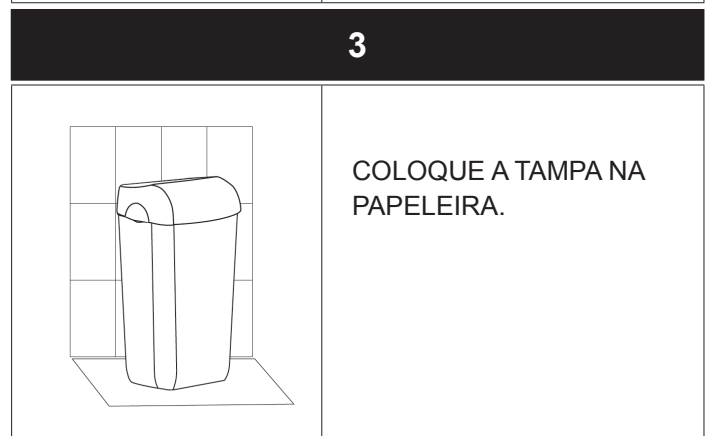

#### INSTRUÇÕES DE LIMPEZA

UTILIZE APENAS PRODUTOS DE LIMPEZA SUAVES E PANOS MACIOS PARA LIMPAR A PAPELEIRA. OS PRODUTOS DE LIMPEZA ABRASIVOS OU AS ESCOVAS DURAS PODEM DANIFICAR A SUPERFÍCIE E COMPROMETER A SUA FUNCIONALIDADE.

#### DESCARTE

NO FINAL DO SEU CICLO DE VIDA, DESCARTE A PAPELEIRA DE UMA FORMA AMBIENTALMENTE RESPONSÁVEL, SEGUINDO OS REGULAMENTOS E DIRETRIZES LOCAIS PARA O DESCARTE DE RESÍDUOS DE PLÁSTICO. ALGUMAS COMUNIDADES PODEM OFERECER PONTOS DE RECOLHA DESIGNADOS OU PROGRAMAS DE RECICLAGEM PARA ESSES MATERIAIS. SE NÃO TIVER A CERTEZA SOBRE O MÉTODO DE DESCARTE ADEQUADO OU PRECISAR DE MAIS INFORMAÇÕES, CONTACTE O FORNECEDOR.

1:1

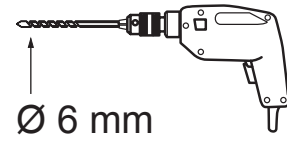
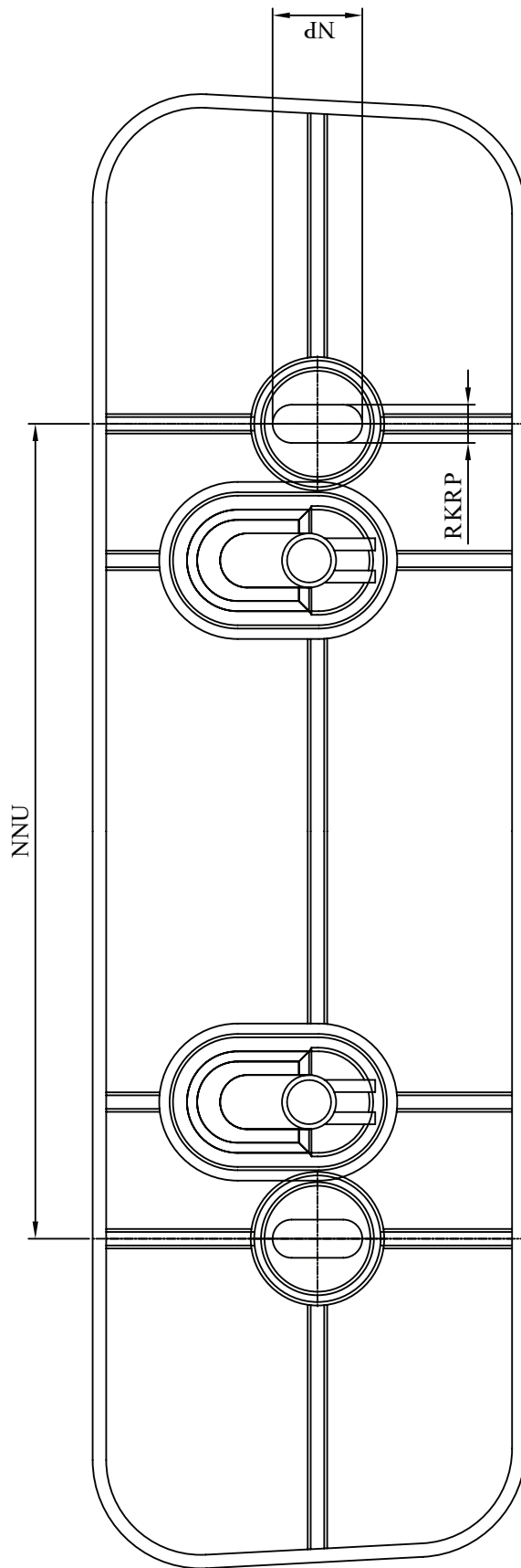

2 UNID.

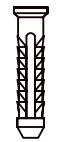

2 UNID.

